

Reg. No.: _____

Name: _____

FIRST SEMESTER B.TECH DEGREE EXAMINATION, JANUARY 2016

Course Code: BE 100

Course Name: ENGINEERING MECHANICS

Max. Marks: 100

Duration: 3 Hours

PART A*Answer ALL questions. Each question carries 5 marks*

1. What are the laws of mechanics? State and explain them.
2. Find the support reactions of a cantilever beam of span 6m carrying a UDL of 6kN/m.
3. Explain moment of inertia and polar moment of inertia
4. Explain laws of friction.
5. Two equal weights 'W' are connected by a light (weightless) string passing over a frictionless pulley. A small weight 'w' is added to one side, as shown in figure, causing that the weight to fall. Determine the acceleration of the system assuming that the weights start from rest.
6. Explain instantaneous Centre of rotation.
7. Explain the terms free vibration and forced vibration
8. A body is vibrating with simple harmonic motion of amplitude 120mm and frequency 5cps. Calculate the maximum velocity and acceleration of the body.

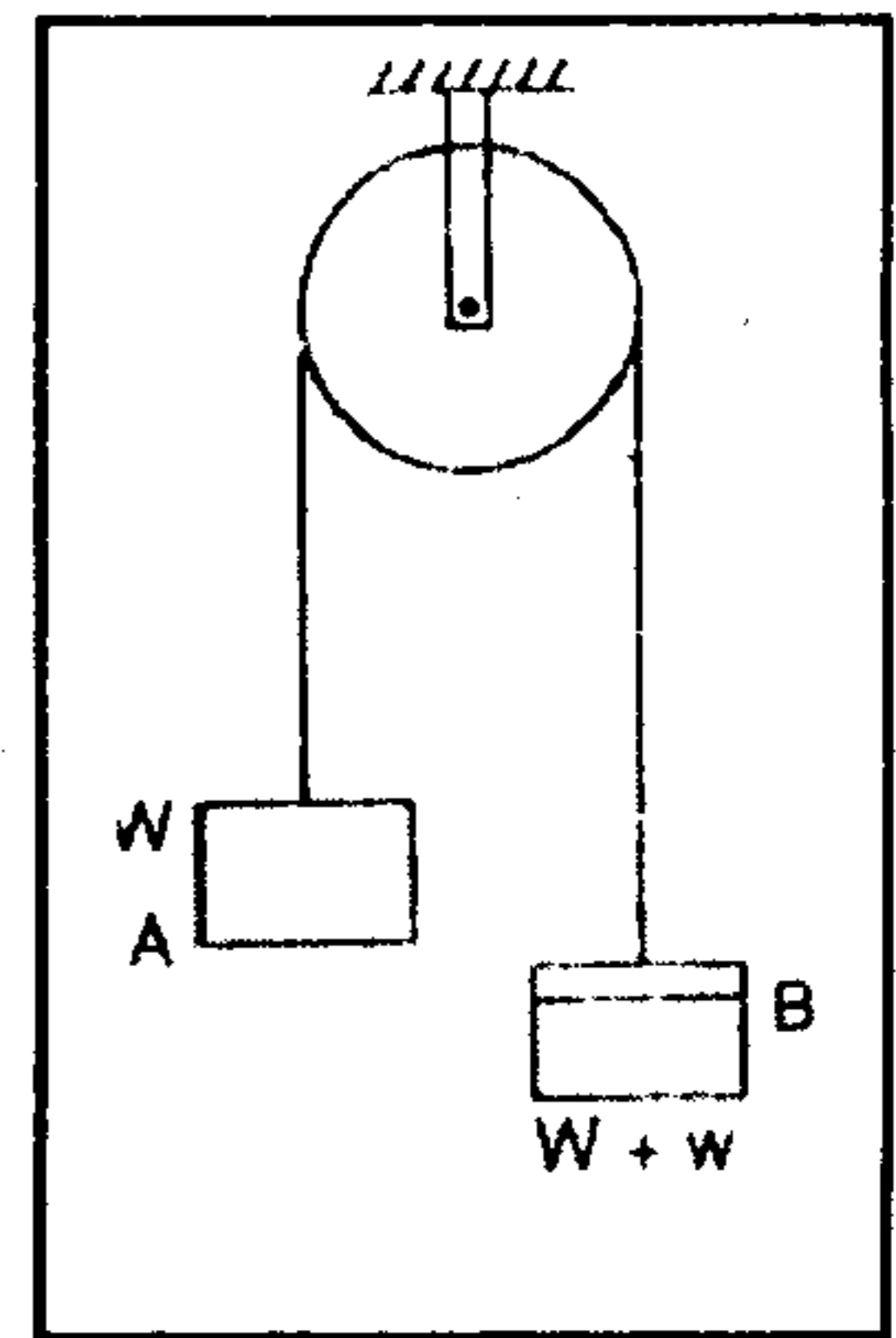

www.classnotesforyou.com

PART B*Answer any 2 complete questions each having 10 marks*

9. Block P = 5kg and block Q of mass m kg are suspended through a chord, which is in equilibrium as shown in the figure. Determine the mass of block Q.

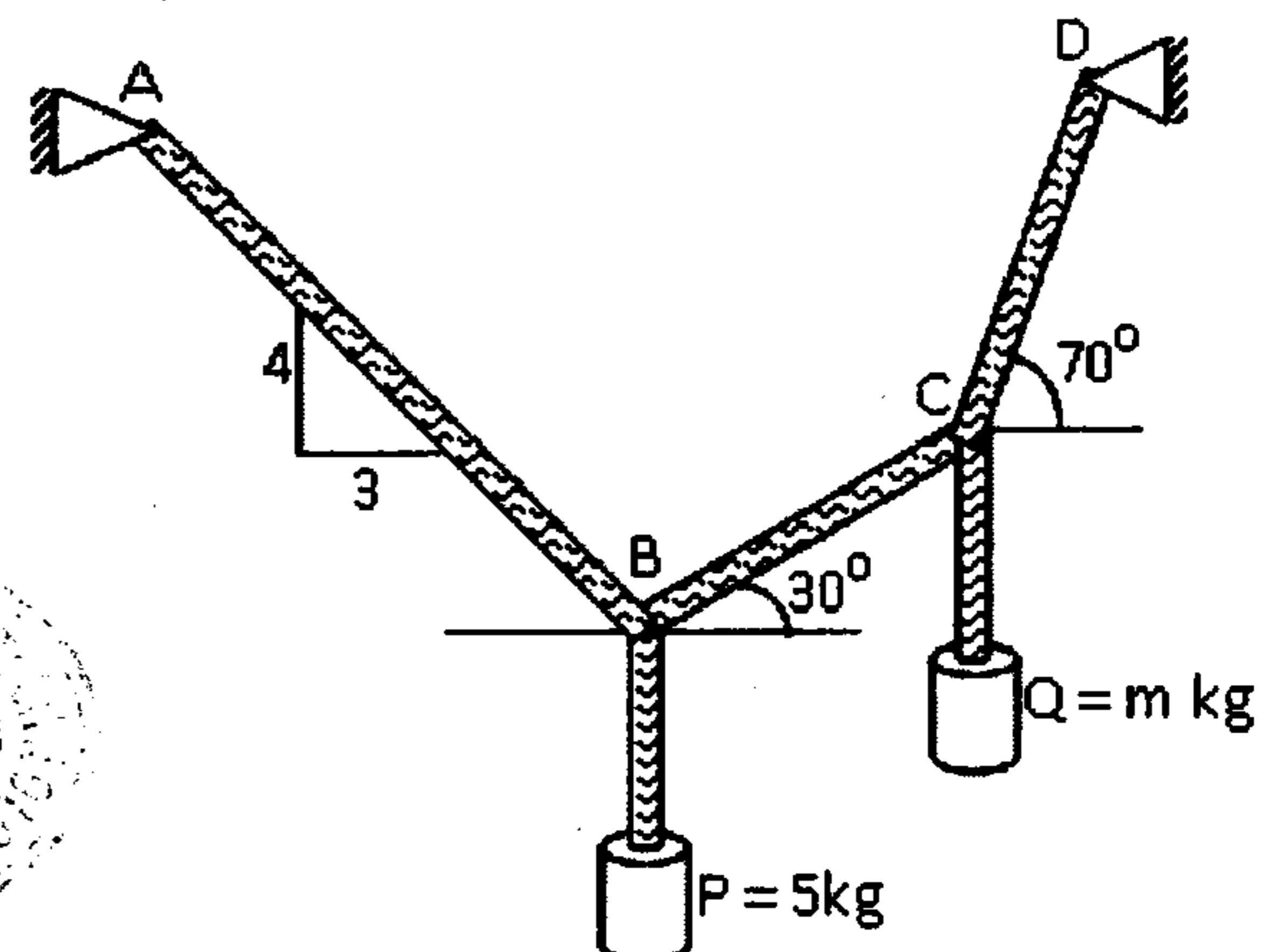

10. Two homogeneous spherical balls rest between two vertical walls as shown in figure. The radius of smaller ball is 16 cm and weight is 1.15 kN. The radius of the larger ball is 24 cm and its weight is 3.45 kN. The distance between the walls is 72cm. Assuming the contact surfaces to be smooth, (a) Draw the free body diagram of two balls (b) Determine the reactions at A, B and C.

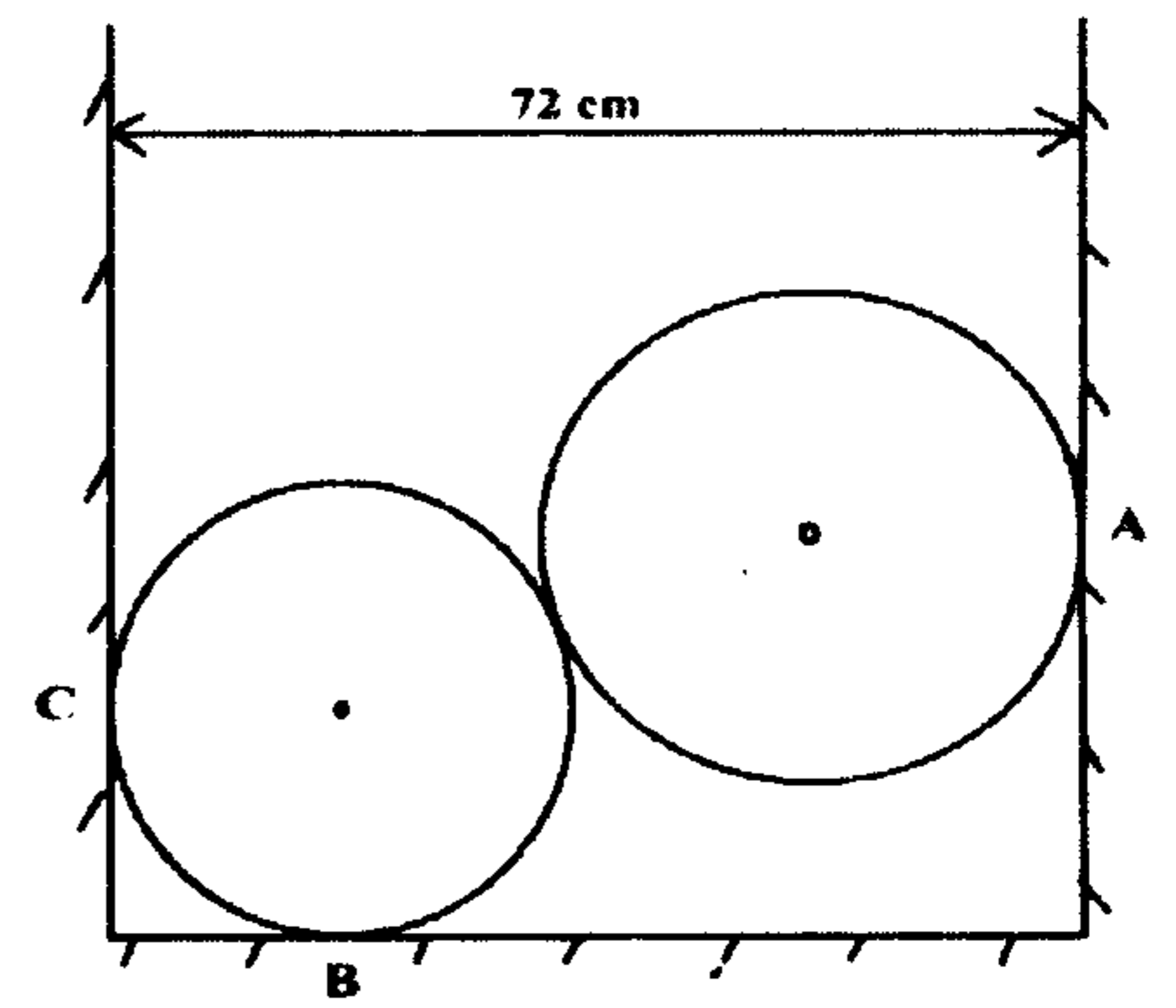

11. Determine the reactions at the supports A and B of the beam loaded as shown in figure below.

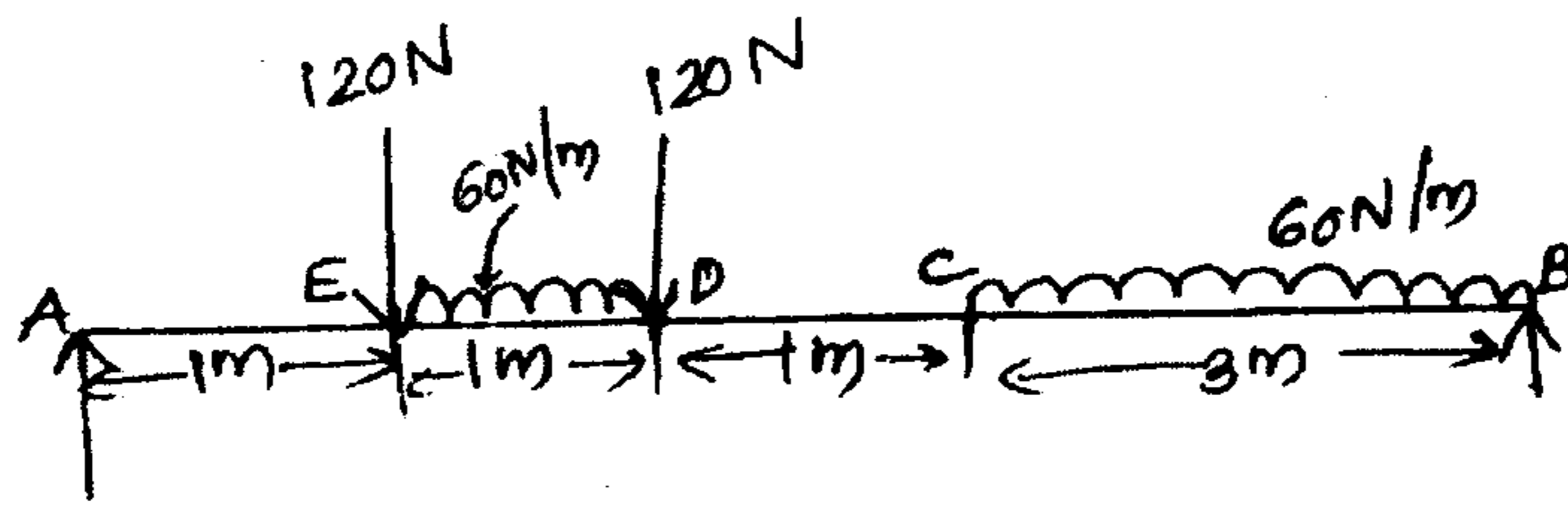

Answer any 2 complete questions each having 10 marks

12. Determine the support reactions of the beam shown in figure

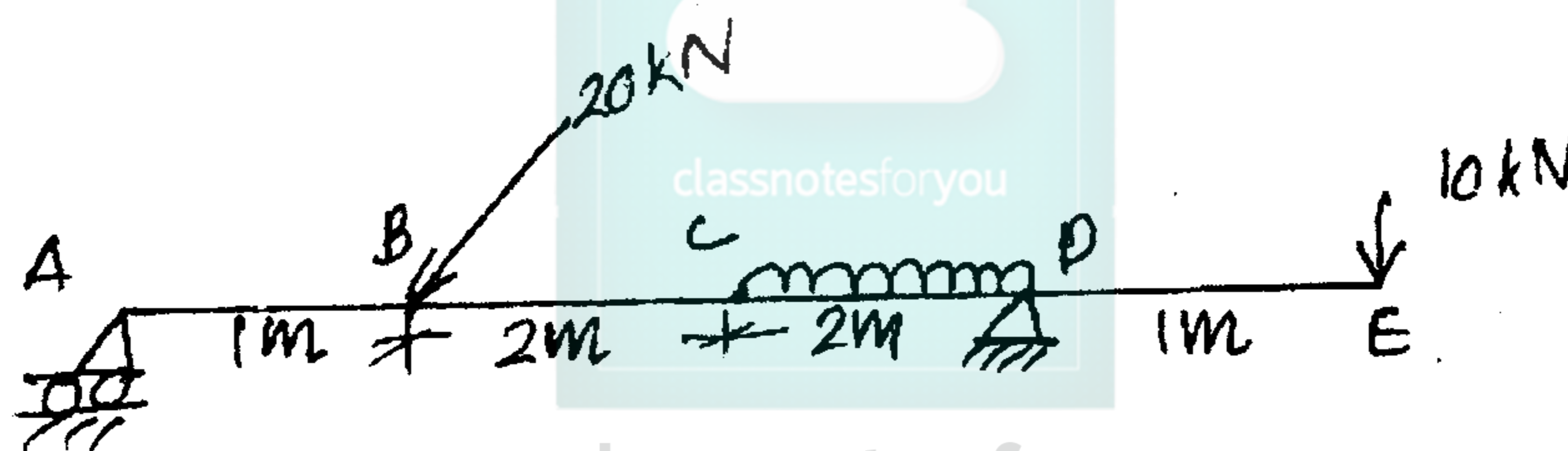

13. Calculate the centroid of the composite area shown in figure:

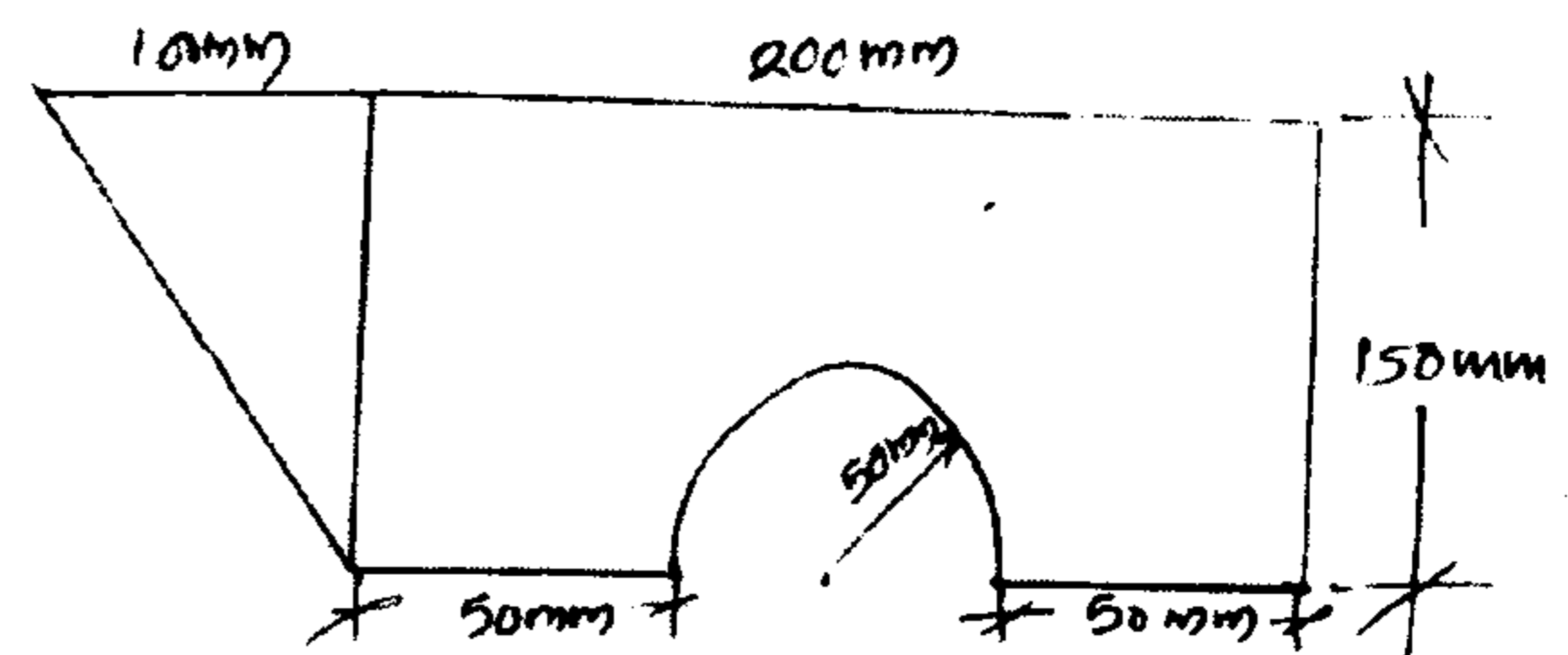

14. Two identical block, A and B of weight W are supported by a rigid bar inclined 45° with horizontal as shown in figure. If both the blocks are in limiting equilibrium find the

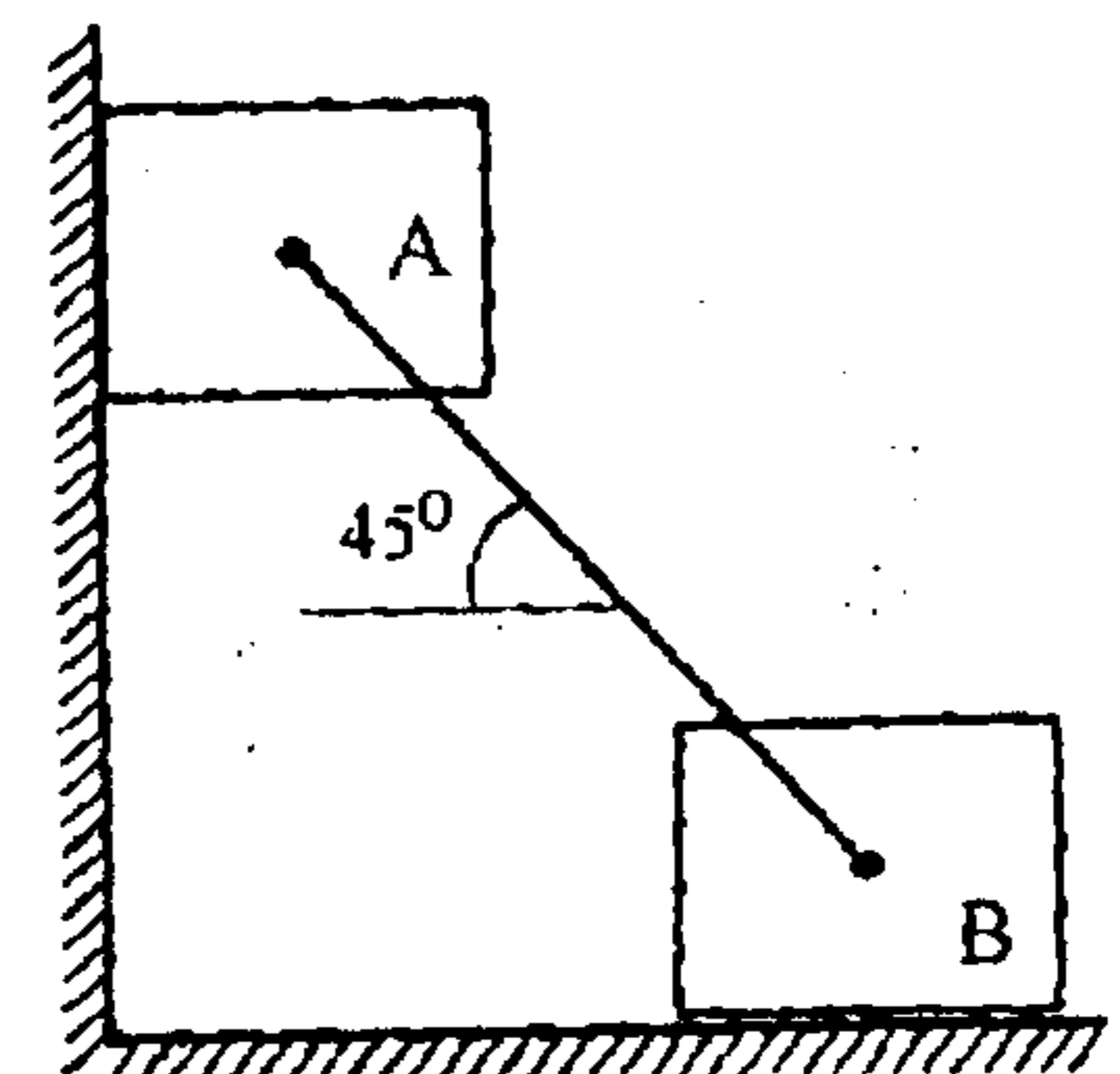

coefficient of friction, between the block and wall assuming it to be same.

Answer any 2 complete questions each having 10 marks

15. A lift has an upward acceleration of 1.2 m/s^2 . (a) What force will a man weighting 750 N exerts on the floor of the lift? (b) What force would he exert, if the lift had an acceleration of 1.2 m/s^2 downwards? (c) What upward acceleration would cause his weight to exert a force of 900 N in the floor?
16. In a reciprocating engine mechanism the crank rotates at a uniform speed of 400rpm. The length of crank and connecting rod are 150mm and 600mm respectively. Find (a) the angular velocity of the connecting rod (b) the velocity of piston when the crank makes an angle of 25° with horizontal.
17. A body of mass 50 kg is suspended by two springs of stiffness 4 kN/m and 6kN/m as shown in figure. The body is pulled 50mm down from its equilibrium position and then released. Find (a) the frequency of oscillation (b) maximum velocity (c) maximum acceleration.

